



# R60

## DESIGN AND SIMPLICITY

FLUSH HANDLES  
FOR SLIDING DOORS



# R60

## MODERN DESIGN FOR FLUSH HANDLES

A fine design characterizes the new **R60 flush handle** that, thanks to the research with the aim to reduce as much as possible all that is needless, results a **modern minimalist design** and perfect for contemporary and interior trend. Aesthetics and design are harmoniously together with handy and simple use.

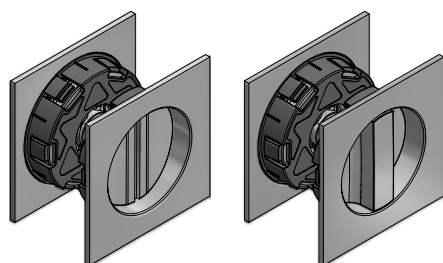
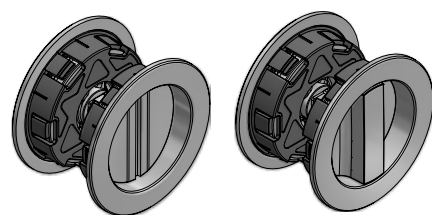

# MODERN DESIGN WITHOUT VISIBLE SCREWS

The innovation of the new R60 flush handle is the new **patented mounting system**, which allows the use of no visible screw on the coin-cutting striker side.

The harmony of lines and soft shape avoid the impact of the projection, fully satisfying the demands of contemporary furniture.



Modern design



Patented mounting system



Without visible screws

## NEW



### R60 flush handles

Modern design **without the use of grub screws** and **no screws in sight**

## OLD



### Standard flush handles

Standard design with the use of grub screws and with visible screw



# ADVANTAGES

The new larger size Reguitti R60 are more functional and never unwieldy. Simplicity and fast assembling (no tools needed), combined with self-adjustable of thickness, put R60 in the top tier of flush handles for sliding doors.



OVERSIZE  
FLUSH HANDLES

Upsize flush handles  
ø 60 and 60x60 mm

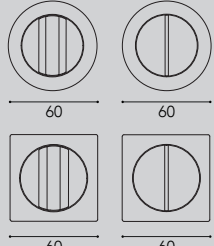

SUPER FAST MANUAL  
ASSEMBLING

Super fast manual assembling  
without using tools, screws  
and glue



SELF-ADJUSTABLE

Self-adjustable for door  
thickness from to 35-52 mm

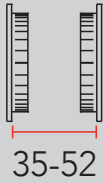

NO  
PROJECTION

No projection  
of the thumb turn

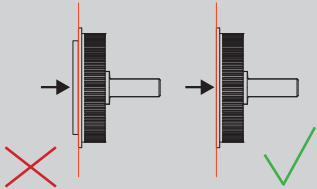

# NEW **PATENTED** ASSEMBLING SYSTEM



## R60 SIZES

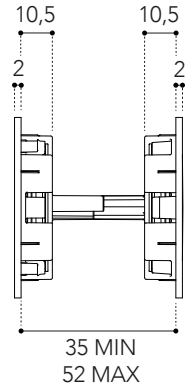
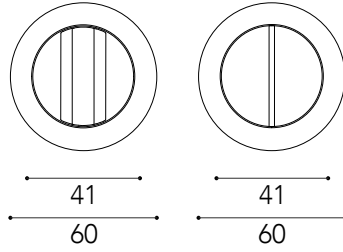
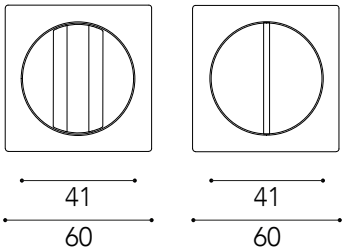

# DOOR DRILLING

## R60CP - Q60PI MOUNTING

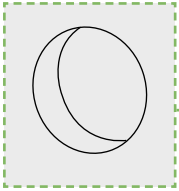

**DOOR DRILLING**  
 $\varnothing$  48 mm

**TOLLERANCE**  
 + 0,4 mm / - 0,1 mm

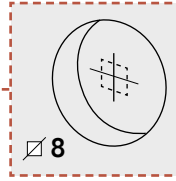
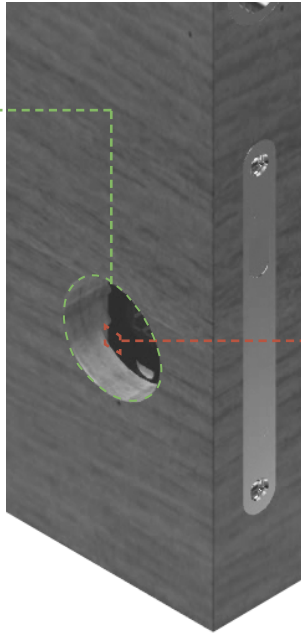

**R60 CP**  
 The lock square must be positioned in the centre to the  $\varnothing$  48 mm hole  
**MAXIMUM TOLLERANCE**  
 $\pm$  0,3 mm

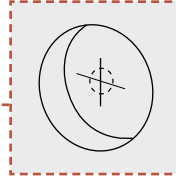

**Q60 PI (pin type key hole)**  
 Central position of the square lock in relation to the  $\varnothing$  48 mm hole  
**MAXIMUM TOLLERANCE**  
 $\pm$  0,3 mm

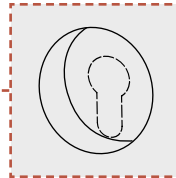

**Q60 PI (Euro profile cylinder hole)**  
 Displacement of the  $\varnothing$  48 mm hole with respect to S1 lock drilling  
**MAXIMUM TOLLERANCE**  
 $\pm$  0,3 mm

## R60 MOUNTING

1. Insert part A
2. Insert part B

### CAUTION

Do not insert the complete flush pull plate ("A" assembled to "B")  
 Insert first part "A"  
 and then part "B"

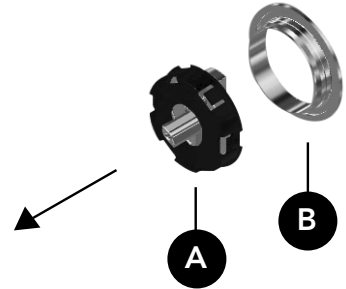
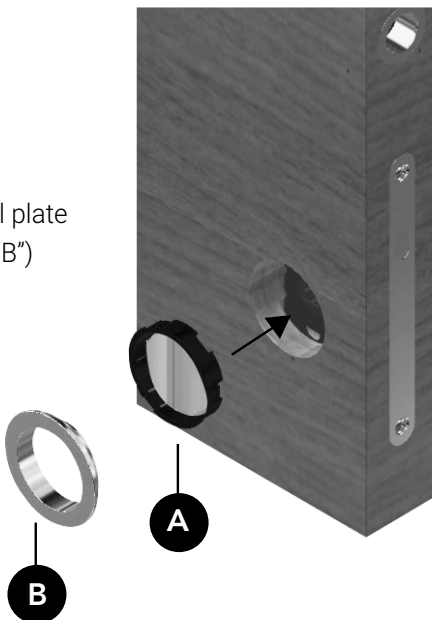

**R60**  
 Assembling and disassembling system video



# R60

R60CP00Q - ZSC

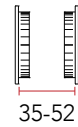

DOOR  
THICKNESS

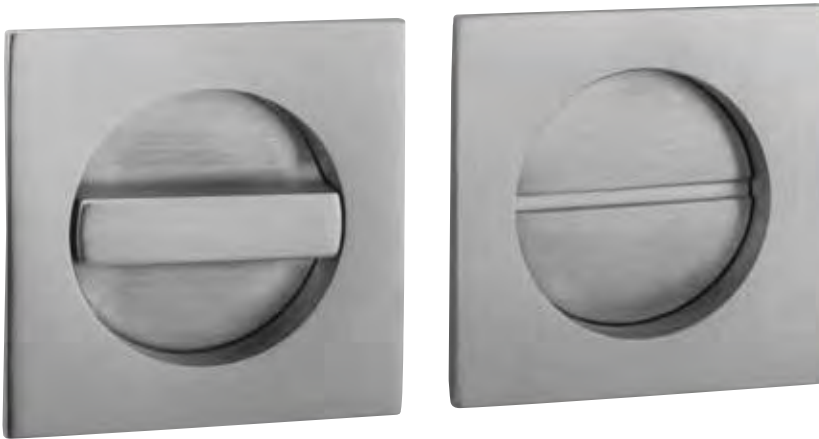

R60KF00Q - ZSC

KIT

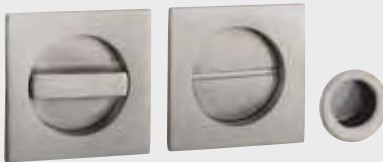

## Finish



**ZSC**  
Satin chrome  
plated zamak

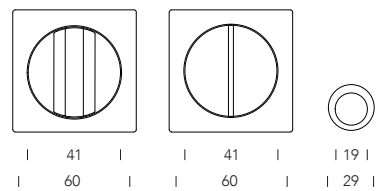

R60KS00Q - ZSC

KIT

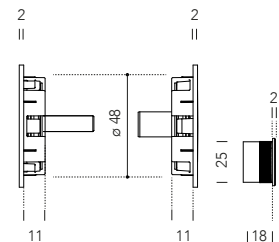



# R60

R60CP00Q - SNV



DOOR  
THICKNESS



R60KF00Q - SNV

KIT



## Finish



**SNV**  
Satin nickel plated  
varnished

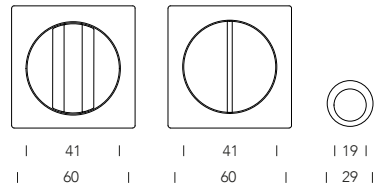

R60KS00Q - SNV

KIT

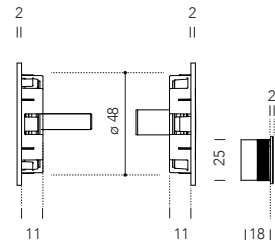

# R60

R60CP00Q - PVD INOX



DOOR  
THICKNESS

35-52



R60KF00Q - PVD INOX

KIT



## Finish



**PVD INOX**

PVD Satin Stainless Steel

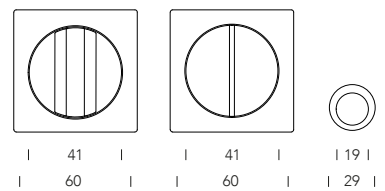

R60KS00Q - PVD INOX

KIT

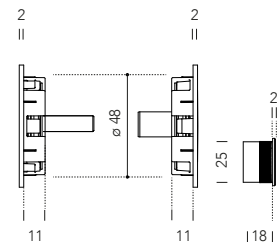

# R60

R60CP00Q - PSB

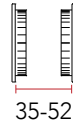

DOOR  
THICKNESS



## Finish



**PSB**  
PVD Satin black

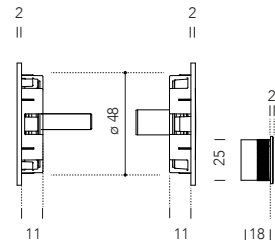
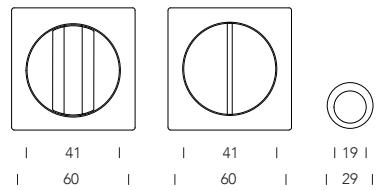

# R60

R60CP00Q - NR

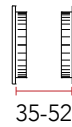

DOOR  
THICKNESS

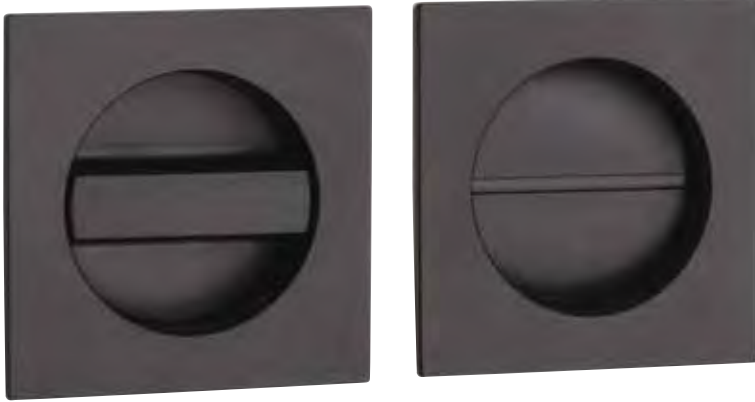

R60KF00Q - NR

KIT

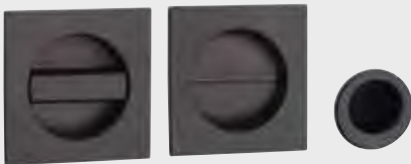

## Finish



**NR**

Matt black painted  
RAL 9005

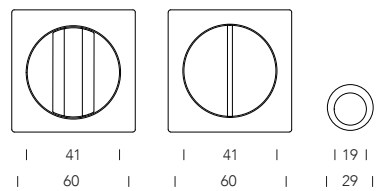

R60KS00Q - NR

KIT

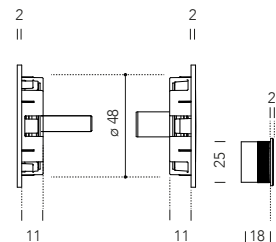

# NEW LOCK CLASSIC 026 SR

Lock with square hole mm 8 - backset = E50  
round edge



## Finishes available for the lock



**SAT. CROM.**  
Satin chrome plat.

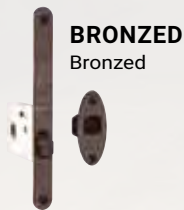

**BRONZED**  
Bronzed



**NR**  
Matt black painted

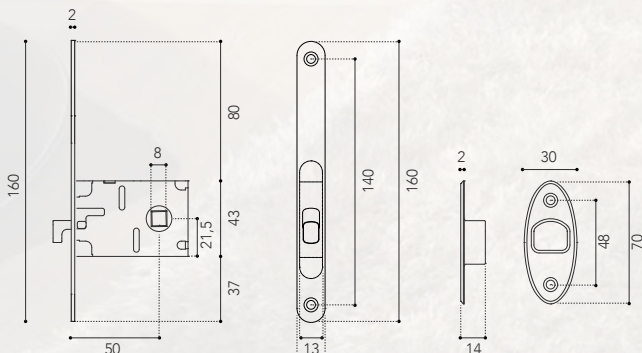



# R60

R60CP - ZSC

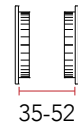

DOOR  
THICKNESS

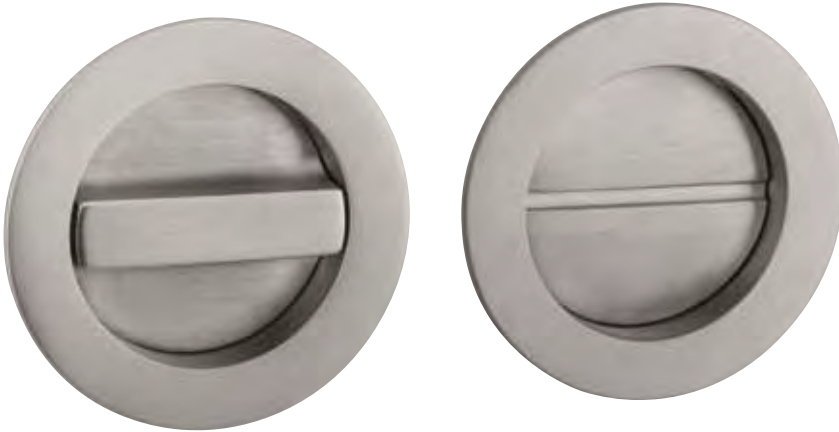

R60KF - ZSC

KIT



## Finish



**ZSC**  
Satin chrome  
plated zamak

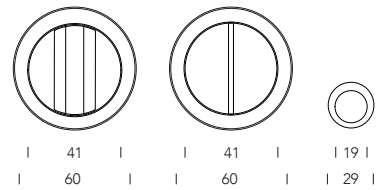

R60KS - ZSC

KIT

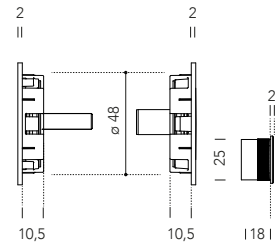

# R60

R60CP - SNV



DOOR  
THICKNESS



R60KF - SNV

KIT



## Finish



**SNV**  
Satin nickel plated  
varnished

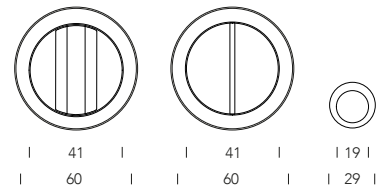

R60KS - SNV

KIT

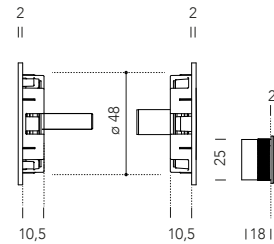

# R60

R60CP - PVD INOX



DOOR  
THICKNESS



## Finish



**PVD INOX**  
PVD Satin Stainless Steel

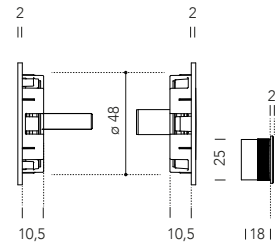
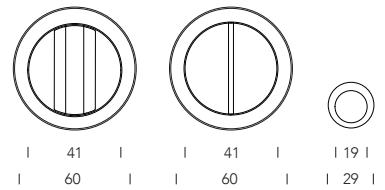

# R60

R60CP - PSB



DOOR  
THICKNESS



R60KF - PSB

KIT



## Finish



**PSB**  
PVD Satin black

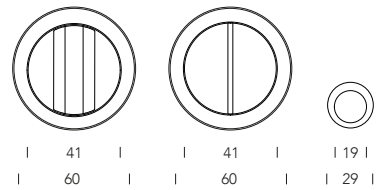

R60KS - PSB

KIT

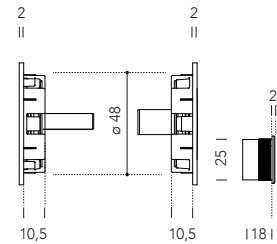

# R60

R60CP - NR

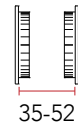

DOOR  
THICKNESS

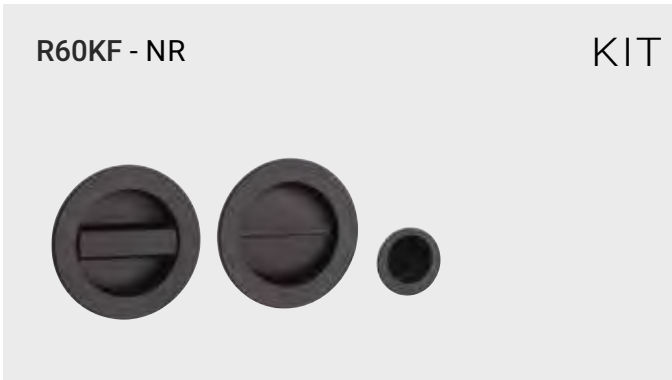
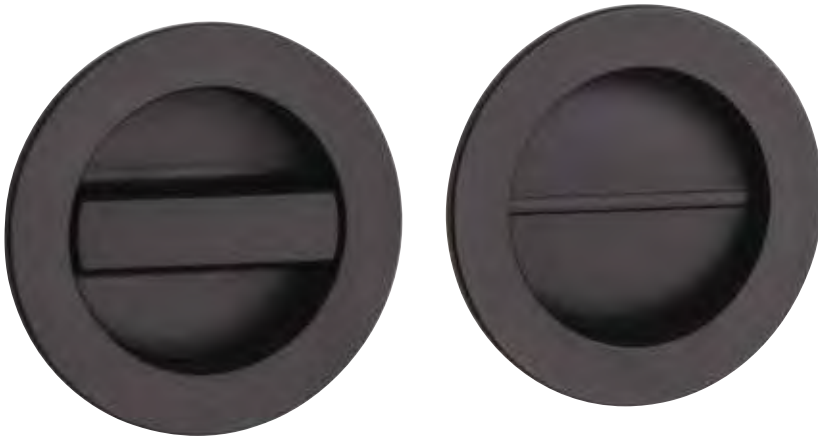

## Finish



**NR**  
Matt black painted  
RAL 9005

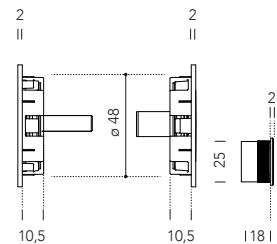
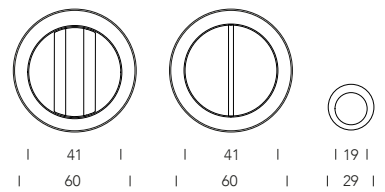



# R60

R60CP - BGO



DOOR  
THICKNESS



R60KF - BGO

KIT



## Finish



**BGO**  
Matt scratched bronzed

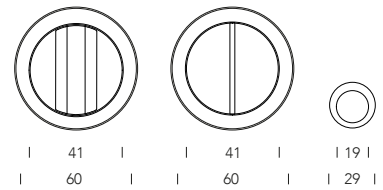

R60KS - BGO

KIT

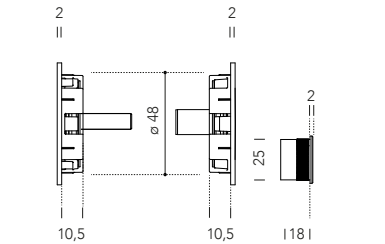
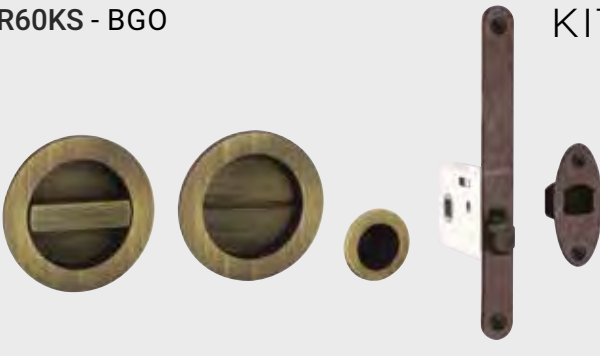

# R60

R60CP - AN



DOOR THICKNESS

35-52



R60KF - AN

KIT



## Finish



**AN**  
Antique brass

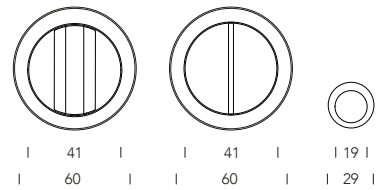

R60KS - AN

KIT

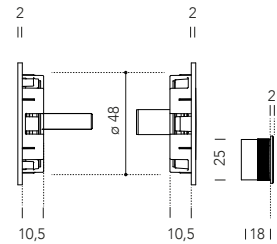

# R60

R60CP - AGV



DOOR THICKNESS



R60KF - AGV

KIT



## Finish



**AGV**  
Old silver

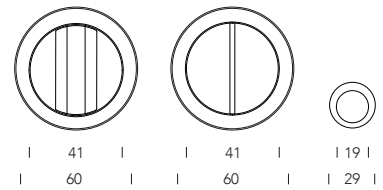

R60KS - AGV

KIT

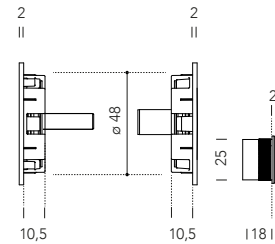

# Q60

Q60KS027



DOOR  
THICKNESS

35-50

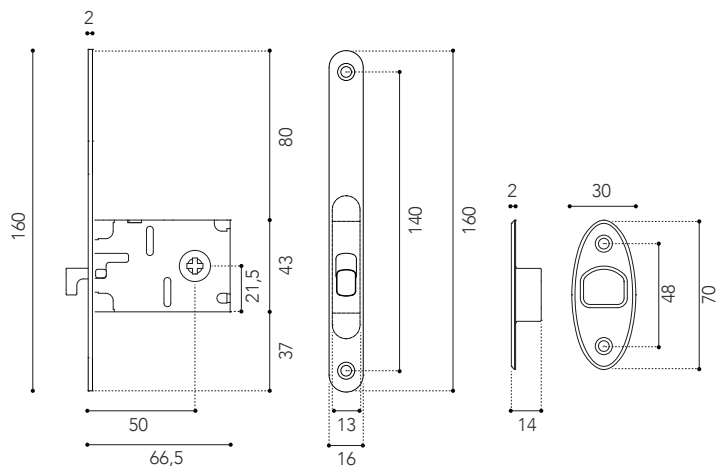
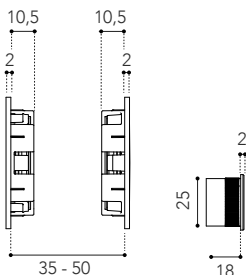
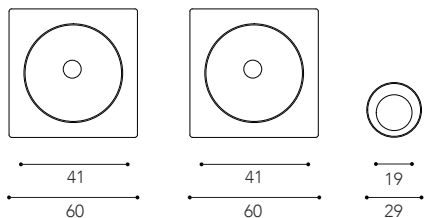

## Finishes



**ZSC**  
Satin chrome plated  
zamak



**SNV**  
Satin nickel plated  
varnished



**PVD INOX**   
PVD Satin Stainless Steel



**PSB**   
PVD Satin black



**NR**   
Matt black painted  
RAL 9005

# T60

T60KS027



DOOR THICKNESS

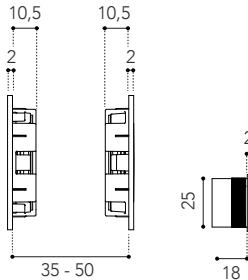
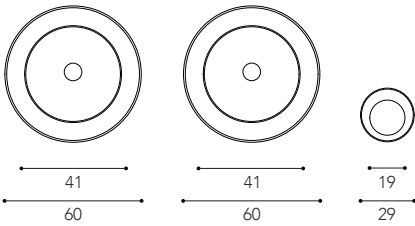

## Finishes

- 
**OSC**  
 Satin chrome plated brass
- 
**SNV**  
 Satin nickel plated varnished
- 
**PVD INOX**   
 PVD Satin Stainless Steel
- 
**PSB**   
 PVD Satin black
- 
**NR**   
 Matt black painted RAL 9005
- 
**BGO**   
 Matt scratched bronzed
- 
**AN**   
 Antique brass
- 
**AGV**   
 Old silver

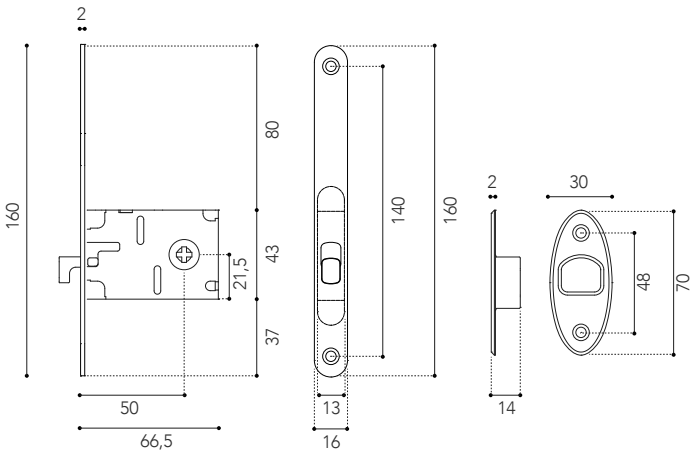



# Q60

Q60KS028

DOOR THICKNESS  
MIN 35

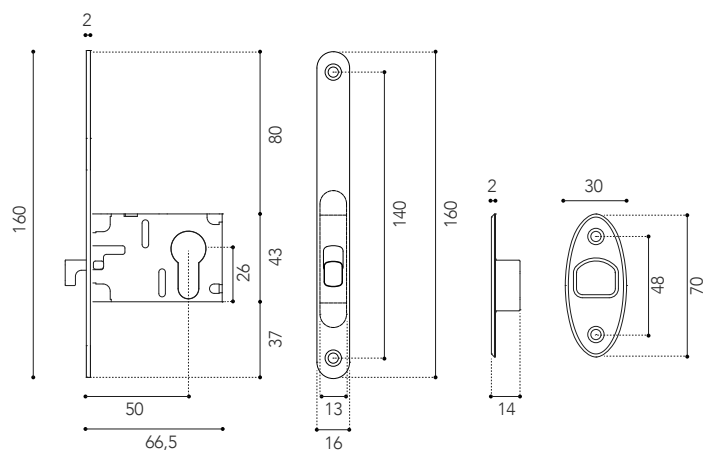
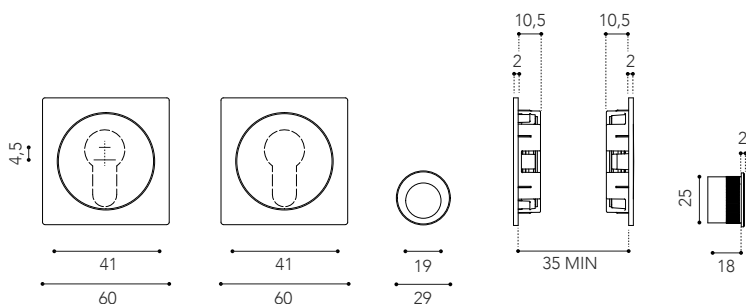

## Finishes

-  **ZSC**  
Satin chrome plated zamak
-  **SNV**  
Satin nickel plated varnished
-  **PVD INOX**   
PVD Satin Stainless Steel
-  **PSB**   
PVD Satin black
-  **NR**   
Matt black painted RAL 9005



# Q60

Q60PI002 - ZSC

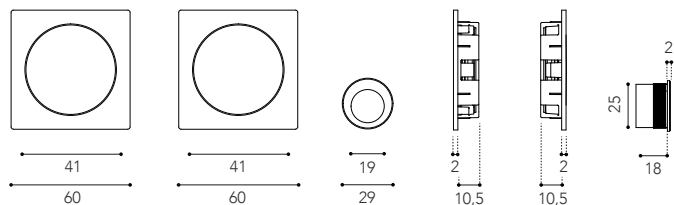

Q60KF002 - ZSC

KIT



## Finishes



**ZSC**  
Satin chrome plated  
zamak



**SNV**  
Satin nickel plated  
varnished



**PVD INOX**   
PVD Satin Stainless Steel



**PSB**   
PVD Satin black



**NR**   
Matt black painted  
RAL 9005

# T60

T60PI002 - OSC

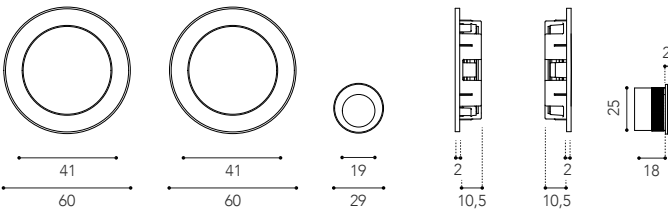

T60KF002 - OSC

KIT

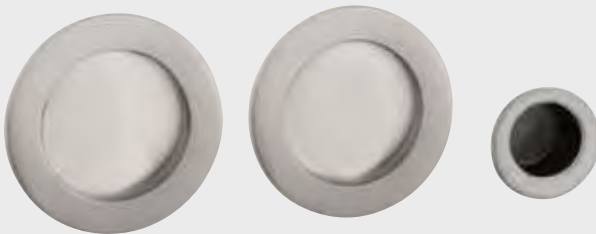

## Finishes

-  **OSC**  
Satin chrome plated brass
-  **SNV**  
Satin nickel plated varnished
-  **PVD INOX**   
PVD Satin Stainless Steel
-  **PSB**   
PVD Satin black
-  **NR**   
Matt black painted RAL 9005
-  **BGO**   
Matt scratched bronzed
-  **AN**   
Antique brass
-  **AGV**   
Old silver





### North America

---



.....  
[www.amesburytruth.com](http://www.amesburytruth.com)

### UK and Ireland

---



.....  
[www.erahomesecurity.com](http://www.erahomesecurity.com)

### International

---



.....  
[www.schlegelgiesse.com](http://www.schlegelgiesse.com)

M.DEP.R6004-21-EN

#### **REGUITTI S.p.A.**

Zona industriale località Fondi 33, 25071 Agnosine (BS), Italy

Phone: +39 0365 896186 | Fax: +39 0365 896137 | email: [salesreguitti@schlegelgiesse.com](mailto:salesreguitti@schlegelgiesse.com)